



CE

**FY400 Series**

**HART® & 4 to 20 mA**

**INTELLIGENT VALVE POSITIONER**

**FOR ACCURATE FINAL CONTROL  
ELEMENT POSITIONING**

- Automatic setup
- Auto-tuning
- Non-contact position measurement
- Diagnosis for control valves including partial stroke test
- Easier preventive maintenance
- Available for remote mounting position sensor
- For linear and rotary applications
- Fully digital PID control capability
- Advanced diagnostics
- Easy assembled on most control valve in the market
- Supports DD, EDDL, and FDT/DTM formats
- Non-polarity power input
- Built-in transient suppression

**HART**  
COMMUNICATION PROTOCOL



**smar**

- Suitable for most valve models and brands;
- Linear stroke from 3 mm up to 100 mm;
- Rotary movement from 30° to 120°;
- HART® configurable;
- User-friendly rotative display;
- Auto-tuning capability;
- Easy installation, quick commissioning and setup;
- Online continuous diagnostics to reduce troubleshooting time, and eliminate unnecessary maintenance;
- Partial stroke test available;
- Built-in transient protection;
- Modularity for all mounting brackets;
- Histogram on valve position available in FRAM memory (Ferroelectric crystal memory) for valve performance enhancement;
- Trend and load factor also available for diagnosis and process improvement;
- Configurable valve characteristic with the most used shapes;
- Customized 16 points characteristic curve;
- Configurable user display;
- Non-contact position sensing;
- Remote mounting available for high vibration and high temperature applications;
- Optional 4 to 20 mA Input for position measurement;
- Up to 100 psi air supply pressure;
- FDT/DTM capability and connectivity;
- Conformity to several standards including flame proof, intrinsically safe and EC directives.

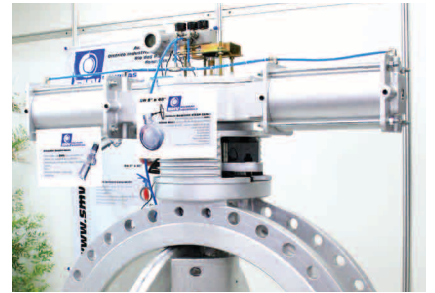

**Product Highlight**

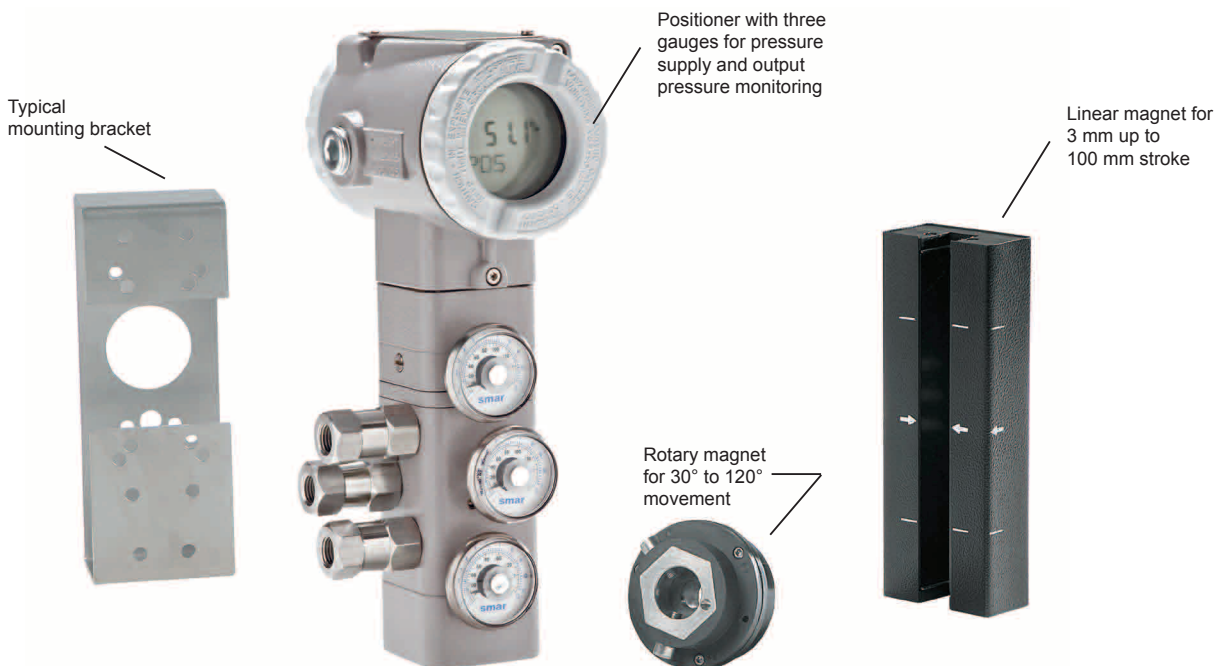

The **FY400** digital positioner uses the most advanced microprocessor to perform an accurate and quick valve positioning. It is a controller which receives a setpoint from the process main controller and move the valve exactly to the ideal position for better process performance.

The **FY400** HART® senses the actual stem valve position and it takes the corrective action according to a fully user configurable strategy. The “non-contact” position sensor (Hall effect based) prevents the inadequacy of links and levers.

The 4 to 20 mA signal (from the controller) is processed at the main digital circuit board. The analog board gets the information from the main circuit board and generates a low power voltage signal to a piezo electric disc in the pressure transducer. It results in a inflection in such disc, moving it nearer or further away from a nozzle in the pressure transducer. This inflection provides a (pilot) pressure variation proportional to the loop controller.

The diaphragm block amplifies the force related to the pilot pressure and pushes down the spool valve, allowing the supply pressure into the valve actuator. On the other hand, the spool valve movement may relieve the pressure from the valve actuator to the atmosphere.

The valve stem will move in response to spool valve movement up to the correct position. The actual valve position is read by the magnet sensor (Hall effect) and feedback to the main circuit board. With the position information (readback signal), the microprocessor will drive a signal to the analog circuit, correcting the valve position.

## FY400 schematic cut view

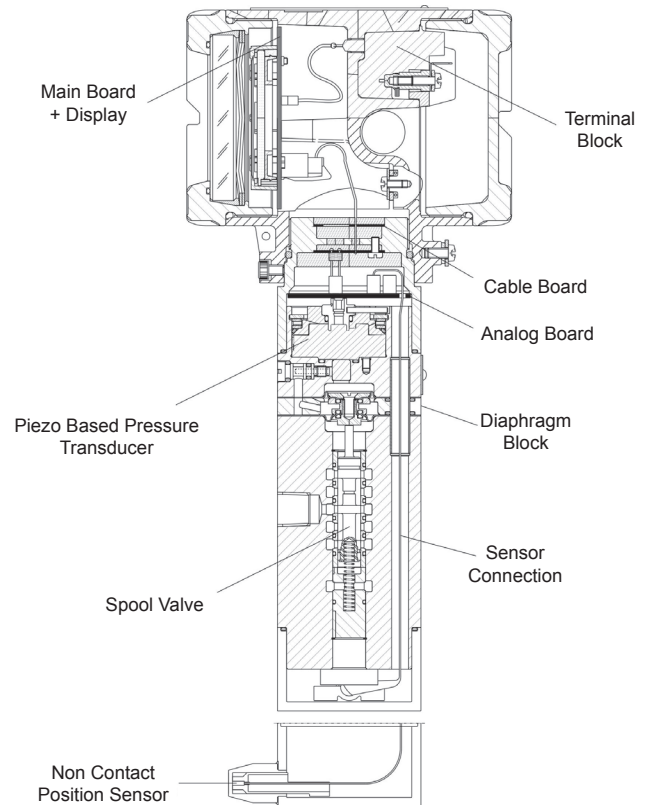

The microprocessor uses the PID algorithm to eliminate the valve position error. The PID parameters are easily tuned automatically through a single command given locally via magnetic tool or a hand held programmer. It is also possible to configure the FY400 via HART® hand-held terminal, the CONF401 configuration tool or any FDT/DTM software application.

## Mounting Brackets

Smar **FY400** HART® is designed for easily assembling in the field or inside the workshop. There are universal mounting brackets (in carbon and stainless steel) for both rotary and linear actuators.

Additionally, a wide variety of customized mounting brackets are available. Check at <http://www.smar.com/products/fy301.asp>.



Smar's internet page for customized mounting brackets selection

**FY400 Linear**

Configurable via software, from 3 mm up to 100 mm stroke, selected from the linear magnet and mounting bracket choices according to the required stroke.

**FY400 Rotary**

Configurable via software from 30° to 120° used with rotary magnet and proper mounting bracket.

**FY400 Local Non-contact Position Sensor**

Regular positioner with integrated position sensor.

**FY400 Remote Non-contact Position Sensor**

Most appropriate on applications involving high temperature and vibration. Also suitable for places with difficult access. Available from 5 m to 20 m cable length.

**FY400 with Pressure Sensors**

In addition to the regular information on the valve and positioner status, the pressure sensors are also useful for advanced diagnosis.



**Parameterization and Diagnostics**

**FY400** is available in HART® technology.

These instruments can be configured with Smar software and other manufacturer configuration tools.

Local adjustment is available in all **FY400**. It is possible to configure the valve type and characteristics, manual or automatic setup, local or remote setpoint, tight-shut-off and other control functions using the magnetic tool.

Smar has developed the AssetView, a management application software, which is a user-friendly Web Tool,

accessed from anywhere and at anytime using an internet browser. It is designed for management and diagnostics of field devices, to ensure reactive, preventive, predictive and proactive maintenance.

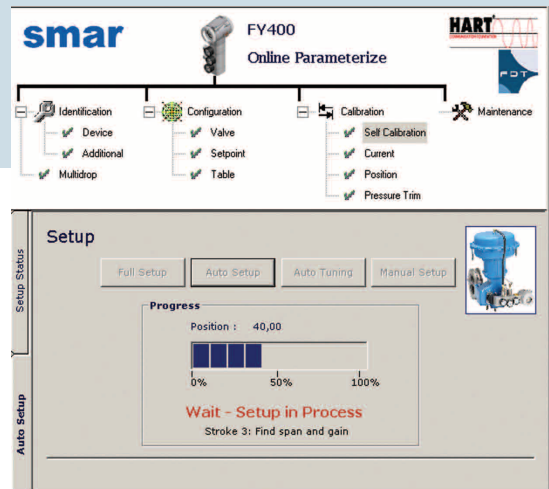

Typical FDT/DTM connected to the FY400 for remote configuration

FY400 with HART® protocol can be configured by:

- Smar CONF401 for Windows and UNIX;
- Smar DDCON 100 for Windows and UNIX;
- Smar HPC401 for most recent models of Palm™;
- Other manufacturers' configuration tools based on DD (Device Description), AMST™, Simatic PDM, and FDT/DTM, such as, FieldCare™, PACTware™, HHT275 and HHT375, PRM Device Viewer.

For FY400 management and diagnostics, AssetView ensures continuous information monitoring.



Local configuration with HPC401 Handheld terminal

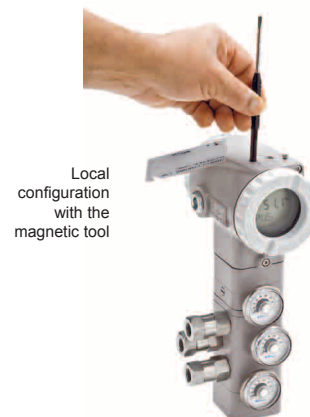

Local configuration with the magnetic tool

Smar **FY400** provides diagnostics on several levels allowing quick maintenance and in a safe way:

- Final Element Level
- Electronics Level
- Alarms Management Level

The **FY400** performs advanced diagnostics even during the auto-setup and auto-tuning procedures. It verifies the integrity of important data for the control valve to work properly such as the characterization data, including valve signature, the customer entered data, the calibration data, among other relevant information about the set valve-actuator.

During the operation, the valve position is continuously checked. Using advanced algorithms, the positioner informs the plant operators of the current valve usage, which may indicate a need of preventive maintenance.

### Additional Diagnostics

The **FY400** is a powerful tool for valve preventive diagnosis, supplying on-line information for most of asset management applications in the market. The main target is a significant maintenance costs reduction for control valves and control final elements.

The majority information is recorded on the FY400 memory capabilities, being uploaded to the application software of the customer choice for further analysis and strategic maintenance decision.

Some of the diagnostic information available are listed below:

Number of strokes

- It gives the level of valve wearing.

Reversals

- Indicate the possibility of a early change of the gaskets.

- Travel Mileage
  - Give overall information about the use of the control final element.
- Actuator Load Factor
  - Show the mechanical efforts and pressure requirements for the valve to reach the ideal position.
- Step Response
  - Useful information for the control loop dynamic evaluation and valuable tool for the loop tuning.

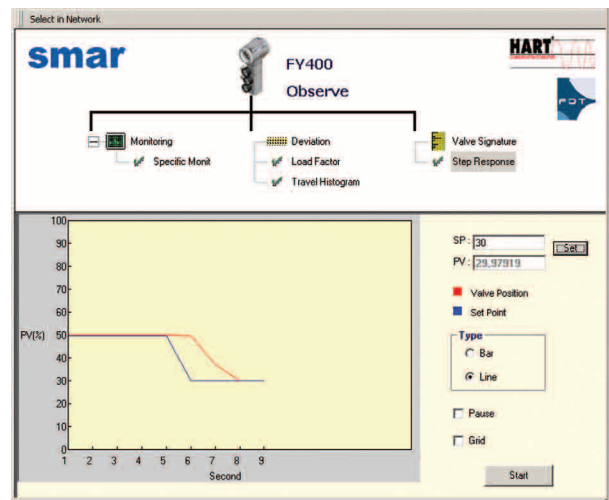

Step Response Graphic

- Valve Signature
  - This is the basic information for the user to predict the need for valve maintenance.

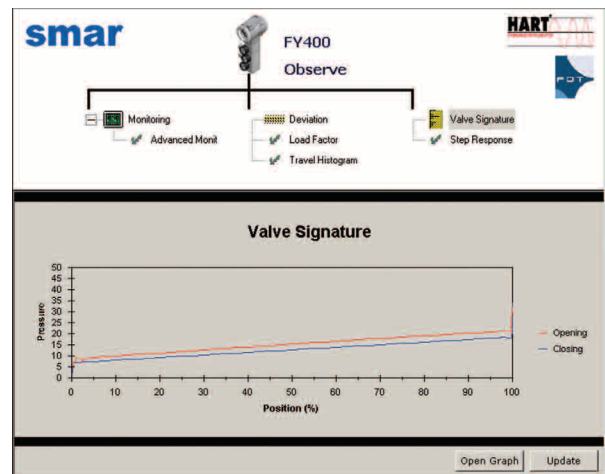

Valve Signature

- Alarms
  - Temperature
  - Low air supply
  - No movement
  - Magnet position
  - Piezo voltage
  - Low current supply

Overview on FY400 Diagnostics

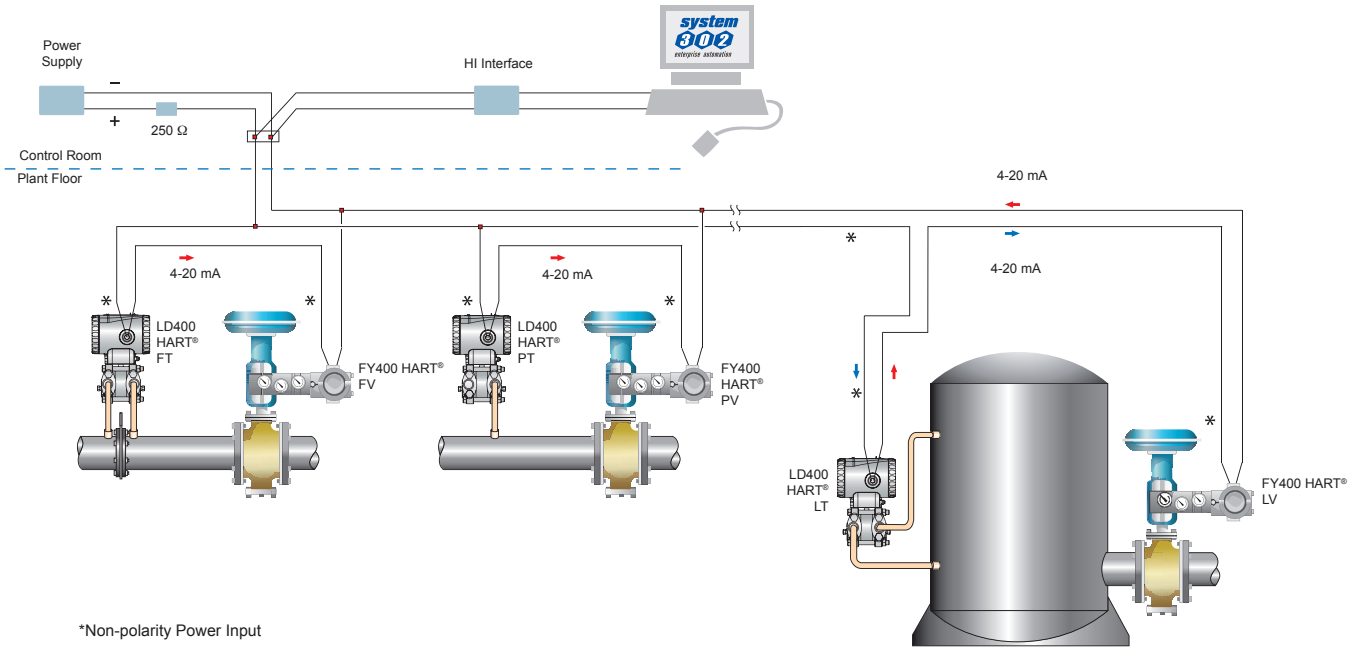

**Technical Characteristics - FY400 HART**

**Functional Specifications**

<b>Travel</b>	Linear Motion: 3 - 100 mm. Rotary Motion: 30° - 120° Rotation Angle.
<b>Input and Communication Protocol</b>	Two-wire, 4-20 mA controlled according to NAMUR NE43 specification, with super-imposed digital HART® Protocol.
<b>Power Supply</b>	Loop-powered. No external supply required. Non-polarity power input. Built-in transient protection. (65 Vdc peak); Overload protection up to 60 Vdc. Critical variables stored in a non-volatile memory.
<b>Indicator</b>	Rotative LCD, with 4½-numerical digit and 5-character alphanumeric. Function and status icons.
<b>Hazardous Area Certifications (Designed to meet the standards for)</b>	Explosion proof, weather proof, dust ignition proof, intrinsically safe, non-incendive according to the NEC500, CEC, CENELEC, IEC standards.
<b>European Directive Information</b>	<p><b>PED Directive (97/23/EC) - Pressure Equipment Directive (Designed to meet the standards for)</b> This product is in compliance with the directive. It was designed and manufactured in accordance with sound engineering practices using standards from ANSI, ASTM, DIN and JIS. Monitoring of the Quality Management System by BVQI (Bureau Veritas Quality International) for the certification of Management Systems.</p> <p><b>EMC Directive (89/336/EEC) - Electromagnetic Compatibility (Designed to meet the standards for)</b> The EMC test was performed according to standard: IEC61326:2002.</p> <p><b>ATEX Directive (94/9/EC) - Explosive Atmosphere, Hazardous Location (Designed to meet the standards for)</b></p>

<b>Flow Characterization</b>	Linear, Equal Percentage, Quick Opening, 16-point freely configurable table. Configurable via local adjustment and digital communication.
<b>Temperature Limits</b>	Operation: -40° to 85 °C (-40° to 185 °F). Storage: -40° to 90 °C (-40° to 194 °F). Display: -10° to 75 °C ( 14° to 167 °F) operation. -40° to 85 °C (-40° to 185 °F) without damage. Remote Sensor Operation: -40° to 105 °C (-40° to 221 °F).
<b>Voltage drop</b>	11 Vdc max / 20 mA (equivalent to 550Ω).
<b>Configuration</b>	By digital communication using the configuration software CONF401, DDCON 100, FDT/DTM, AssetView or HPC401 (for Palm™). <b>FY400 HART®</b> can also be configured using third-party configuration tools, and can be partially configured through local adjustment using the Smar magnetic tool. Writing-protection jumper.
<b>Humidity Limits</b>	0 to 100% RH (Relative Humidity non-condensable).
<b>Minimum current</b>	3.8 mA.
<b>Actual Position Sensing</b>	Non-contact Hall effect sensor. Integral or Remote. Optional 4 to 20 mA input for position measurement.
<b>Pressure Supply</b>	1.4 - 7 bar (20-100 psi). Free of oil, dust and water, as per ANSI/ISA S7.0.01-1996.

## Performance Specifications

<b>Resolution</b>	< 0.1% F.S.
<b>Pressure Supply Effect</b>	Negligible.
<b>Repeatability</b>	< 0.1% F.S.
<b>Consumption</b>	0.35 Nm <sup>3</sup> /h (0.20 SCFM) at 1.4 bar (20 psi) supply. 1.10 Nm <sup>3</sup> /h (0.65 SCFM) at 5.6 bar (80 psi) supply.
<b>Ambient Temperature Effect</b>	0.8%/20 °C of span.
<b>Output Capacity</b>	13.6 Nm <sup>3</sup> /h (8 SCFM) at 5.6 bar (80 psi) supply.
<b>Vibration Effect</b>	± 0.3 % /g of span during the following conditions: 5-15 Hz at 4 mm constant displacement. 15-150 Hz at 2 g. 150-2000 Hz at 1 g. Reference IEC60770-1.
<b>Electro-Magnetic Interference Effect</b>	According to IEC 61326:2002.

**Physical Specifications**

<b>Electrical Connection (1)</b>	<p>½ - 14 NPT M20 X 1.5 PG 13.5 DIN</p>	<p>¾ - 14 NPT (with 316 SST adapter for ½ - 14 NPT). ¾ - 14 BSP (with 316 SST adapter for ½ - 14 NPT). ½ - 14 BSP (with 316 SST adapter for ½ - 14 NPT).</p>
<b>Pneumatic Connections</b>	<p>Supply and output: ¼ -18 NPT. Gage: ⅙ - 27 NPT. (2)</p>	
<b>Material of Construction</b>	<p>Injected low copper aluminum with polyester painting or 316 Stainless Steel housing, with Buna N O-Rings on cover (NEMA 4X, IP 66). Identification Plate: 316 SST.</p>	
<b>Mounting</b>	<p>Universal brackets for rotary motion and linear strokes (See BFY ordering code). Optional customized brackets for most of the market valves and final elements (Consult <a href="http://www.smar.com/products/fy301.asp">www.smar.com/products/fy301.asp</a> for availability and brackets selection). Additional "L" shape bracket, in carbon and Stainless Steel for 2" pipe mounting (remote sensor version).</p>	
<b>Approximate Weights</b>	<p>Without display and mounting bracket: 5.8 kg (316 SST). 2.7 kg (aluminum). Add for digital display: 0.1 kg. Add for aluminum remote sensor: 550 g. Add for remote sensor cable and connectos: 100 g (connectors) plus 45 g/m.</p>	
<b>Pressure Sensors</b>	<p>For air supply, output 1 and output 2 measurement. (Optional); range 0 to 100 psi.</p>	

(1) Certified Hazardous Locations (CEPEL).

(2) The pressure gages for input, output 1 or output 2 pressures, will be supplied with the external housing in SS316 and the wet parts in brass.

HART® is a trademark of HART® Communication Foundation.

All other trademarks are the property of their respective owners.



MODEL	
<b>FY400</b>	Intelligent Valve Positioner
<b>COD.</b>	<b>Communication Protocol</b>
<b>H</b>	HART® & 4 to 20 mA
<b>COD.</b>	<b>Safety Options</b>
<b>0</b>	Standard – For use in measurement and control
<b>COD.</b>	<b>Local Indicator</b>
<b>1</b>	With local digital indicator
<b>COD.</b>	<b>Mounting Bracket</b>
<b>0</b>	Without mounting bracket
<b>1</b>	With mounting bracket
<b>COD.</b>	<b>Electrical Connection</b>
<b>0</b>	1/2" - 14 NPT
<b>A</b>	M20 X 1.5
<b>B</b>	PG 13.5 DIN
<b>COD.</b>	<b>Type of Actuator</b>
<b>1</b>	Rotary - Single Action
<b>2</b>	Rotary - Double Action
<b>3</b>	Linear Stroke Up to 15 mm - Single Action
<b>4</b>	Linear Stroke Up to 15 mm - Double Action
<b>5</b>	Linear Stroke Up to 50 mm - Single Action
<b>6</b>	Linear Stroke Up to 50 mm - Double Action
<b>7</b>	Linear Stroke Up to 100 mm - Single Action
<b>8</b>	Linear Stroke Up to 100 mm - Double Action
<b>A</b>	Linear Stroke Up to 30 mm - Single Action
<b>B</b>	Linear Stroke Up to 30 mm - Double Action
<b>COD.</b>	<b>Indication Gage</b>
<b>0</b>	Without Gage
<b>1</b>	With 1 Gage - Input
<b>2</b>	With 1 Gage - Output
<b>3</b>	With 2 Gage - Input and Output 1
<b>4</b>	With 2 Gage - Output 1 and 2
<b>5</b>	With 3 Gage
<b>Z</b>	Others Specify
<b>COD.</b>	<b>Certification Type</b>
<b>D</b>	Explosion Proof
<b>G</b>	Explosion Proof + Increased Safety
<b>H</b>	Intrinsic Safety + Explosion Proof + Increased Safety
<b>I</b>	Intrinsic Safety
<b>N</b>	Without Certification
<b>P</b>	Protection by Enclosure (Ex-tb; Explosive Dust - Zone 21)
<b>COD.</b>	<b>Certifying Body</b>
<b>0</b>	Without
<b>5</b>	CEPEL: Ex-d, Ex-ia, Ex-dem, IP
<b>SPECIAL OPTIONS (Leave it blank for no optional items)</b>	
<b>COD.</b>	<b>Housing</b>
<b>H0</b>	Aluminum Housing (IP/Type)
<b>H1</b>	316 SST Housing (IP/Type)
<b>H2</b>	Aluminum Housing for saline atmosphere (IP/Type X) (1)
<b>H3</b>	316 SST Housing for saline atmosphere (IP/Type X) (1)
<b>COD.</b>	<b>Painting</b>
<b>P0</b>	Gray Munsell N 6.5 Polyester
<b>P8</b>	Without Painting
<b>P9</b>	Safety Blue Epoxy - Electrostatic Painting
<b>PD</b>	Safety Blue Polyesters - Electrostatic Painting
<b>PH</b>	Special Painting
<b>COD.</b>	<b>Mounting Sensor</b>
<b>R0</b>	Integral Mounting
<b>R1</b>	Remote sensor - 5 m Cable
<b>R2</b>	Remote sensor - 10 m Cable
<b>R3</b>	Remote sensor - 15 m Cable
<b>R4</b>	Remote sensor - 20 m Cable
<b>R5</b>	Feedback 4 to 20 mA - 5 m Cable (2)
<b>R6</b>	Feedback 4 to 20 mA - 10 m Cable (2)
<b>R7</b>	Feedback 4 to 20 mA - 15 m Cable (2)
<b>R8</b>	Feedback 4 to 20 mA - 20 m Cable (2)
<b>COD.</b>	<b>Special Sensor</b>
<b>K0</b>	Without Pressure Sensors
<b>K1</b>	With pressure sensors for air Input and Output
<b>COD.</b>	<b>Optional Items</b>
<b>ZZ</b>	Specify Actuator Model/Company

**FY400** - **H** - **0** - **1** - **1** - **0** - **6** - **5** - **N** - **0** - **\*** - **\*** - **\*** - **\*** - **\***

← TYPICAL MODEL NUMBER

(1) IPW/TYPEX tested for 200 hours according to NBR 8094 / ASTM B 117 standard.  
 (2) Consult Smar for applications in hazardous areas. See note for mounting bracket on BFY ordering code.

MODEL			
BFY	<b>BRACKET (1)</b>		
	<b>COD. Positioner Mounting Bracket (2)</b>		
0	Without Positioner Bracket	3	Linear - Yoke Type
1	Universal Rotary	4	Linear - Pillar Type
2	Universal Linear (Yoke and Pillar)	Z	Others (Specify)
	<b>COD. Magnet Mounting Bracket</b>		
0	Without Magnet Mounting Bracket	3	Linear up to 50 mm
1	Rotary	4	Linear up to 100 mm
2	Linear up to 30 mm	Z	Others (Specify)
	<b>COD. Positioner Mounting Bracket Material</b>		
7	Carbon Steel Bracket and Accessories in SST		
C	Carbon Steel Bracket		
I	Stainless Steel Bracket		
N	Not applicable		
Z	Others - Specify		
	<b>COD. Magnet Bracket Material</b>		
C	Carbon Steel Bracket		
I	Stainless Steel Bracket		
N	Not applicable		
Z	Others - Specify		
	<b>COD. Optional Items</b>		
ZZ	Leave it blank for no optional items		

BFY - 1 | 0 | 7 | C - \* ← TYPICAL MODEL NUMBER

(1) Consult [www.smar.com](http://www.smar.com) for customized mounting bracket.  
 (2) When choosing the remote sensor version, an additional "L" shape bracket is included, for 2" tube mounting.

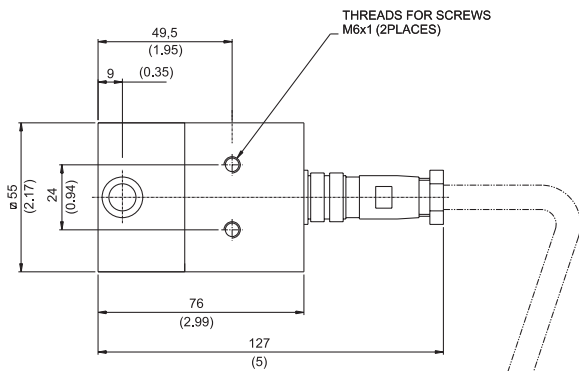
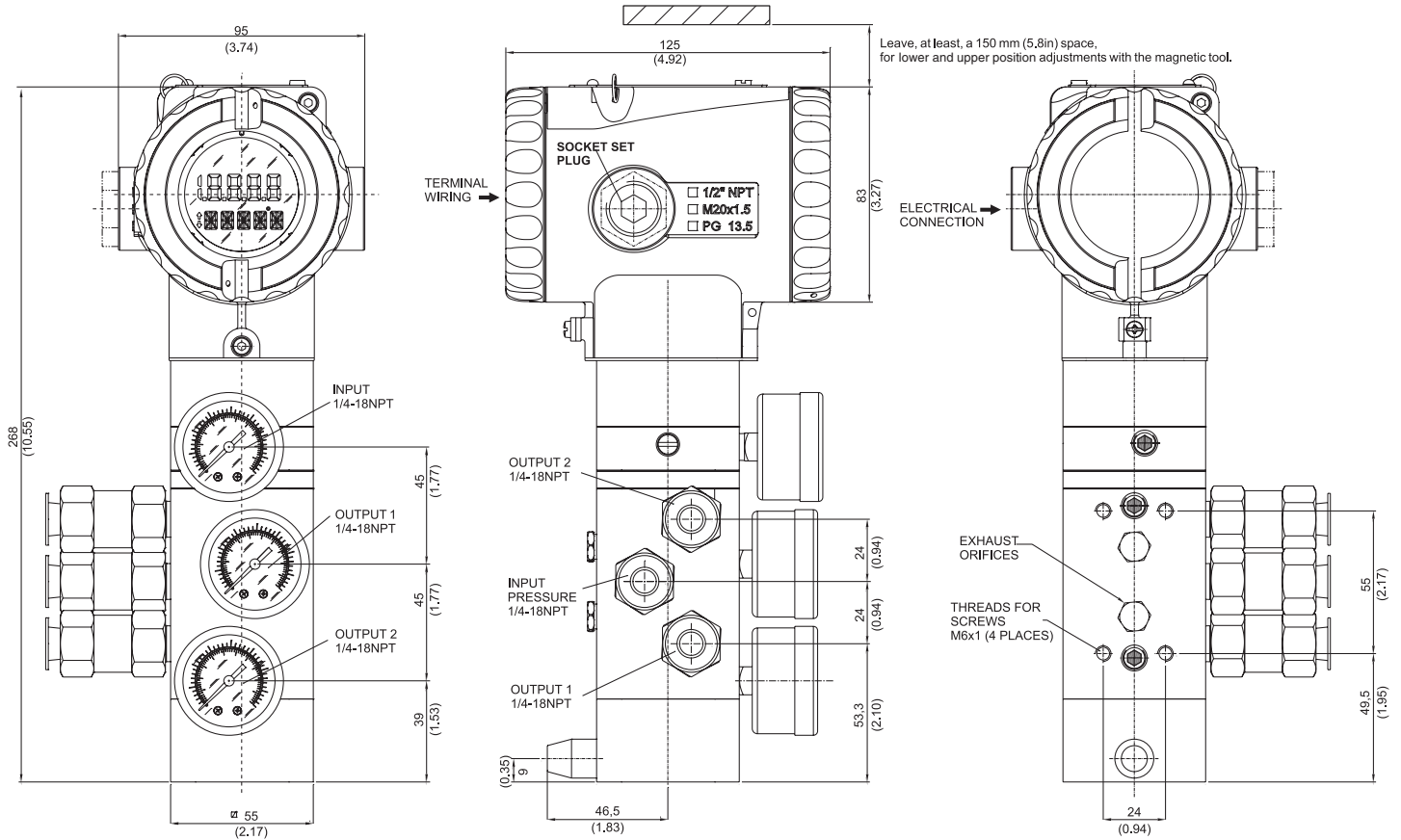

FLEXIBLE SHIELDED CABLE  
 AVAILABLE LENGTHS:  
 5 m, 10 m, 15 m, 20 m

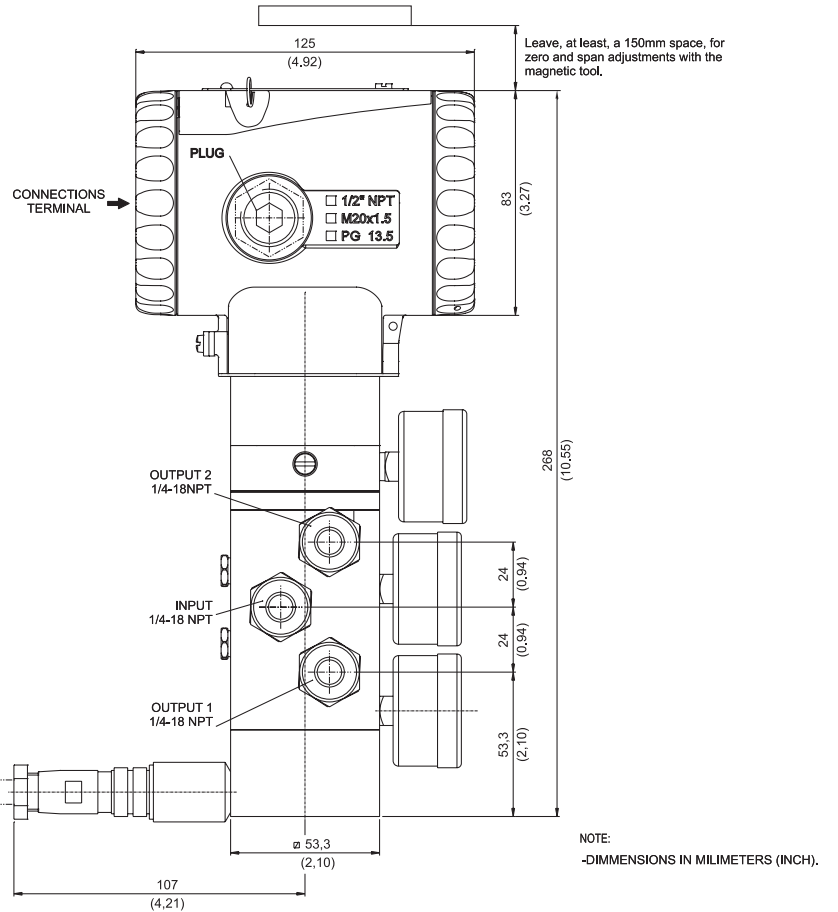

**smar**  
www.smar.com

Specifications and information are subject to change without notice.  
Up-to-date address information is available on our website.

web: [www.smar.com/contactus.asp](http://www.smar.com/contactus.asp)



F Y 4 0 0 C E